

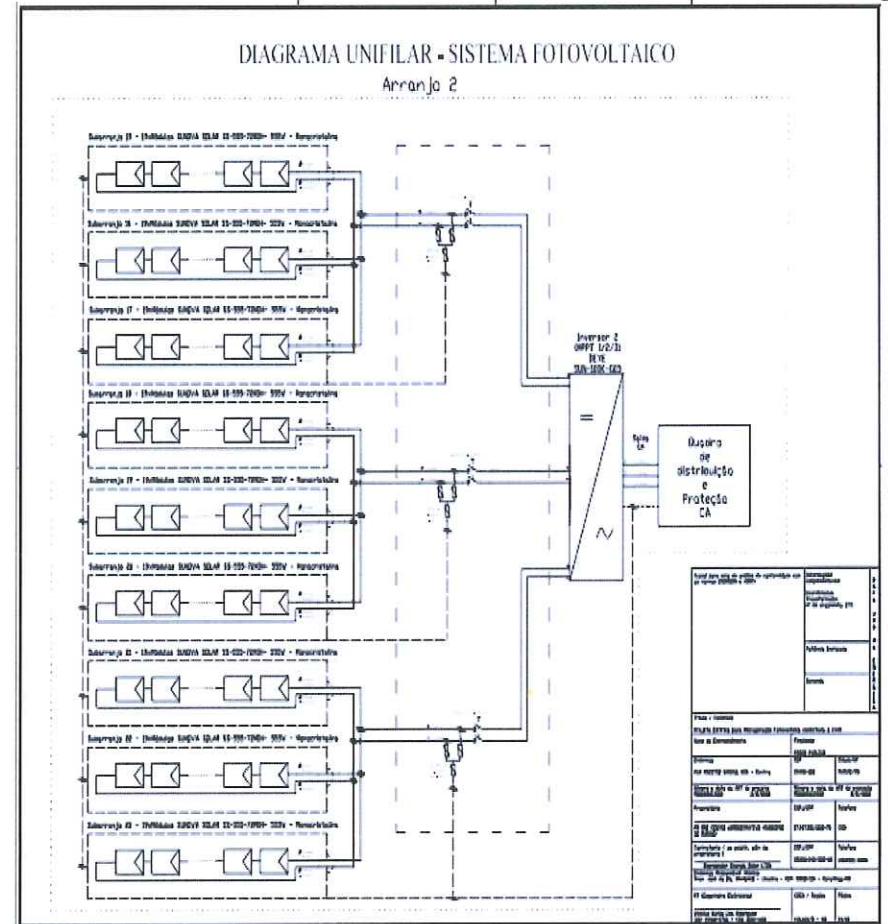

Prefeitura Municipal de Muriaé
Estado de Minas Gerais
C.G.C.: 17.947.581/0001-76

RELATÓRIO FOTOGRÁFICO

Objeto do Contrato: ENERGIA SOLAR		Empresa Contratada: Empreender Energia Solar Ltda	
Local da Obra (Bairro, município e UF): Centro Administrativo da Prefeitura Municipal de Muriaé		CNPJ: 35.886.443/0001-06	ORDEM DE SERVIÇO: Projeto.
PREGÃO 092/2022	Contrato: 195001/22	Data: 18/11/2022	

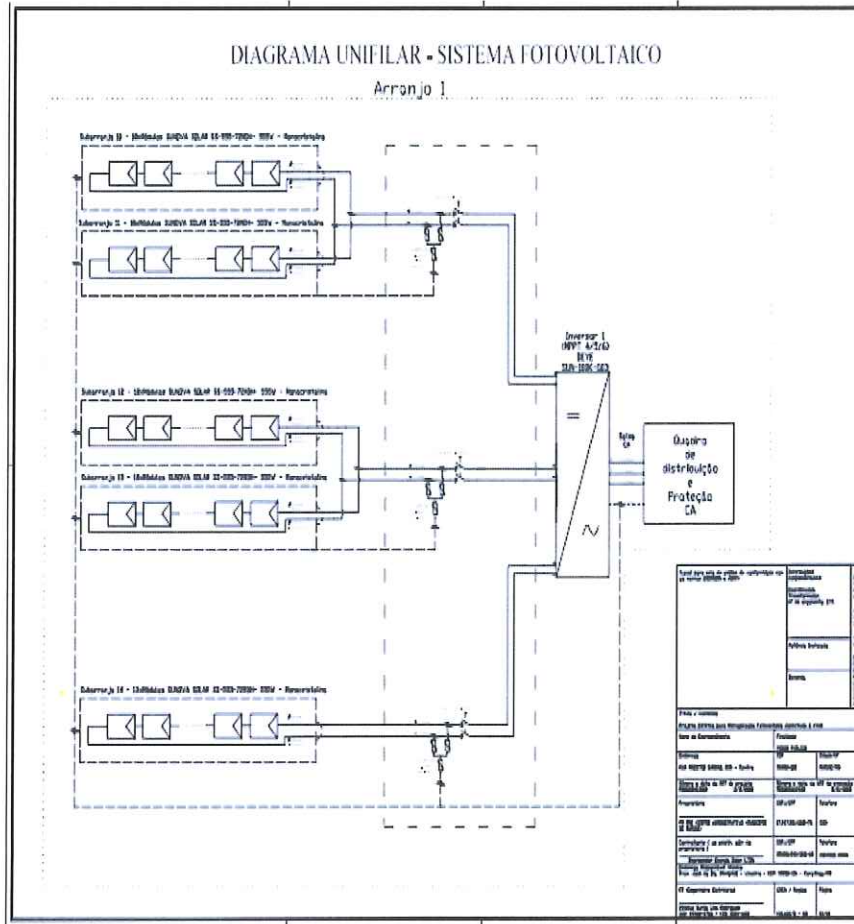



Prefeitura Municipal de Muriaé
Estado de Minas Gerais
C.G.C.: 17.947.581/0001-76

RELATÓRIO FOTOGRÁFICO

Objeto do Contrato: ENERGIA SOLAR		Empresa Contratada: Empreender Energia Solar Ltda	
Local da Obra (Bairro, município e UF): Centro Administrativo da Prefeitura Municipal de Muriaé		CNPJ: 35.886.443/0001-06	ORDEM DE SERVIÇO: Projeto.
PREGÃO 092/2022	Contrato: 195001/22	Data: 29/11/2022	

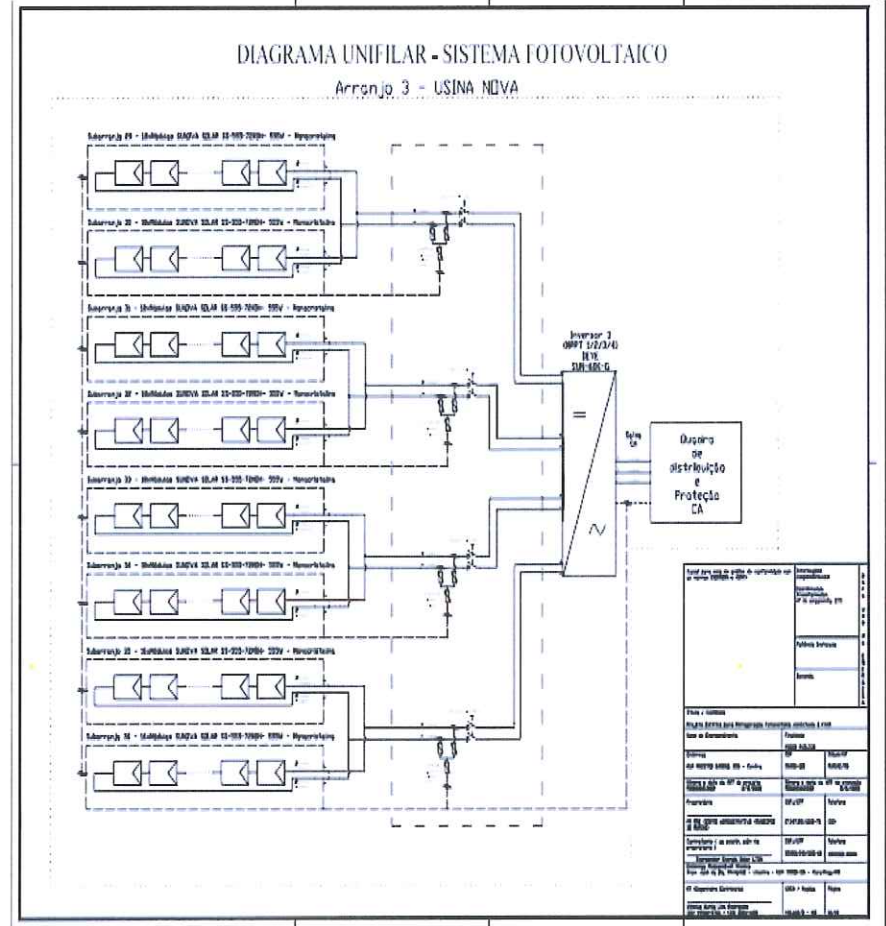
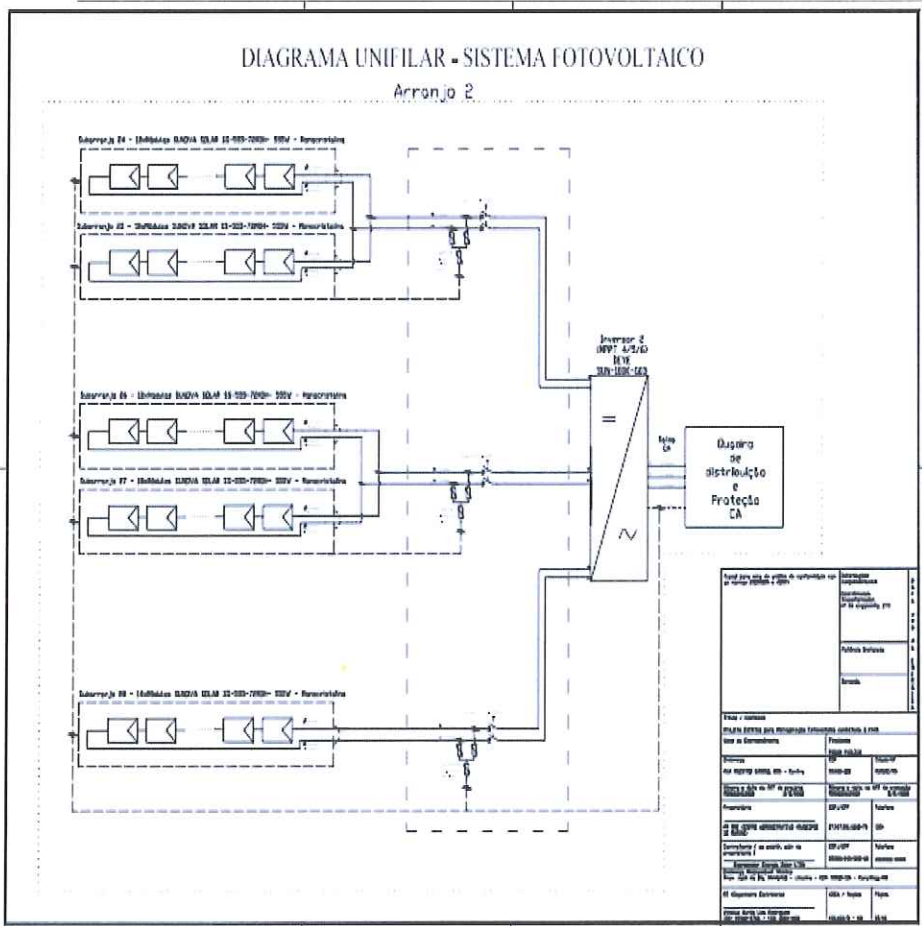



Prefeitura Municipal de Muriaé
Estado de Minas Gerais
C.G.C.: 17.947.581/0001-76

RELATÓRIO FOTOGRÁFICO

Objeto do Contrato:	ENERGIA SOLAR	Empresa Contratada:	Empreender Energia Solar Ltda
Local da Obra (Bairro, município e UF):	Centro Administrativo da Prefeitura Municipal de Muriaé	CNPJ:	35.886.443/0001-06
PREGÃO	092/2022	Contrato:	195001/22
		Data:	2/1/2023

ORDEM DE SERVIÇO: Hook e Perfil





Prefeitura Municipal de Muriaé
Estado de Minas Gerais
C.G.C.: 17.947.581/0001-76

RELATÓRIO FOTOGRÁFICO

Objeto do Contrato:	ENERGIA SOLAR	Empresa Contratada:	Empreender Energia Solar Ltda
Local da Obra (Bairro, município e UF):	Centro Administrativo da Prefeitura Municipal de Muriaé	CNPJ: 35.886.443/0001-06	ORDEM DE SERVIÇO: Hook e Perfil
PREGÃO 092/2022	Contrato: 195001/22	Data: 2/1/2023	





Prefeitura Municipal de Muriaé
Estado de Minas Gerais
C.G.C.: 17.947.581/0001-76

RELATÓRIO FOTOGRÁFICO

Objeto do Contrato:	ENERGIA SOLAR	Empresa Contratada:	Empreender Energia Solar Ltda
Local da Obra (Bairro, município e UF):	Centro Administrativo da Prefeitura Municipal de Muriaé	CNPJ:	35.886.443/0001-06
PREGÃO	092/2022	Contrato:	195001/22
		Data:	2/1/2023
		ORDEM DE SERVIÇO: Hook e Perfil	





Prefeitura Municipal de Muriaé
Estado de Minas Gerais
C.G.C.: 17.947.581/0001-76

RELATÓRIO FOTOGRÁFICO

Objeto do Contrato:	ENERGIA SOLAR	Empresa Contratada:	Empreender Energia Solar Ltda
Local da Obra (Bairro, município e UF):	Centro Administrativo da Prefeitura Municipal de Muriaé	CNPJ:	35.886.443/0001-06
PREGÃO	092/2022	Contrato:	195001/22
		Data:	2/1/2023

ORDEM DE SERVIÇO: Hook e Perfil

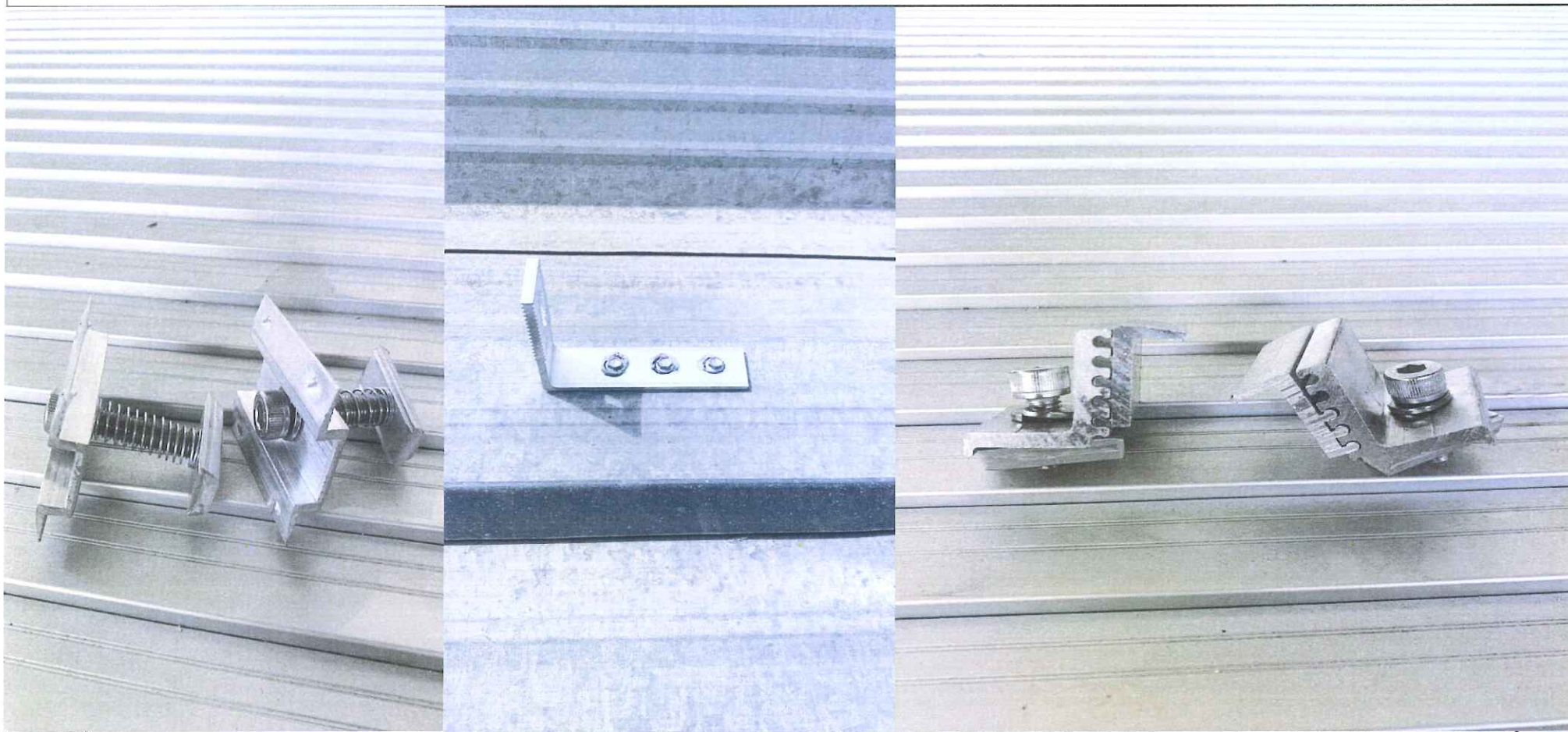



Prefeitura Municipal de Muriaé
Estado de Minas Gerais
C.G.C.: 17.947.581/0001-76

RELATÓRIO FOTOGRÁFICO

Objeto do Contrato:	ENERGIA SOLAR	Empresa Contratada:	Empreender Energia Solar Ltda
Local da Obra (Bairro, município e UF):	Centro Administrativo da Prefeitura Municipal de Muriaé	CNPJ:	35.886.443/0001-06
PREGÃO	092/2022	Contrato:	195001/22
		Data:	2/1/2023
		ORDEM DE SERVIÇO:	Modulos



RELATÓRIO FOTOGRÁFICO



Prefeitura Municipal de Muriaé
Estado de Minas Gerais
C.G.C.: 17.947.581/0001-76

Objeto do Contrato: ENERGIA SOLAR		Empresa Contratada: Empreender Energia Solar Ltda	
Local da Obra (Bairro, município e UF): Centro Administrativo da Prefeitura Municipal de Muriaé		CNPJ: 35.886.443/0001-06	ORDEM DE SERVIÇO: Modulos
PREGÃO 092/2022	Contrato: 195001/22	Data: 2/1/2023	





Prefeitura Municipal de Muriaé
Estado de Minas Gerais
C.G.C.: 17.947.581/0001-76

RELATÓRIO FOTOGRÁFICO

Objeto do Contrato: ENERGIA SOLAR		Empresa Contratada: Empreender Energia Solar Ltda	
Local da Obra (Bairro, município e UF): Centro Administrativo da Prefeitura Municipal de Muriaé		CNPJ: 35.886.443/0001-06	ORDEM DE SERVIÇO: Modulos
PREGÃO 092/2022	Contrato: 195001/22	Data: 2/1/2023	

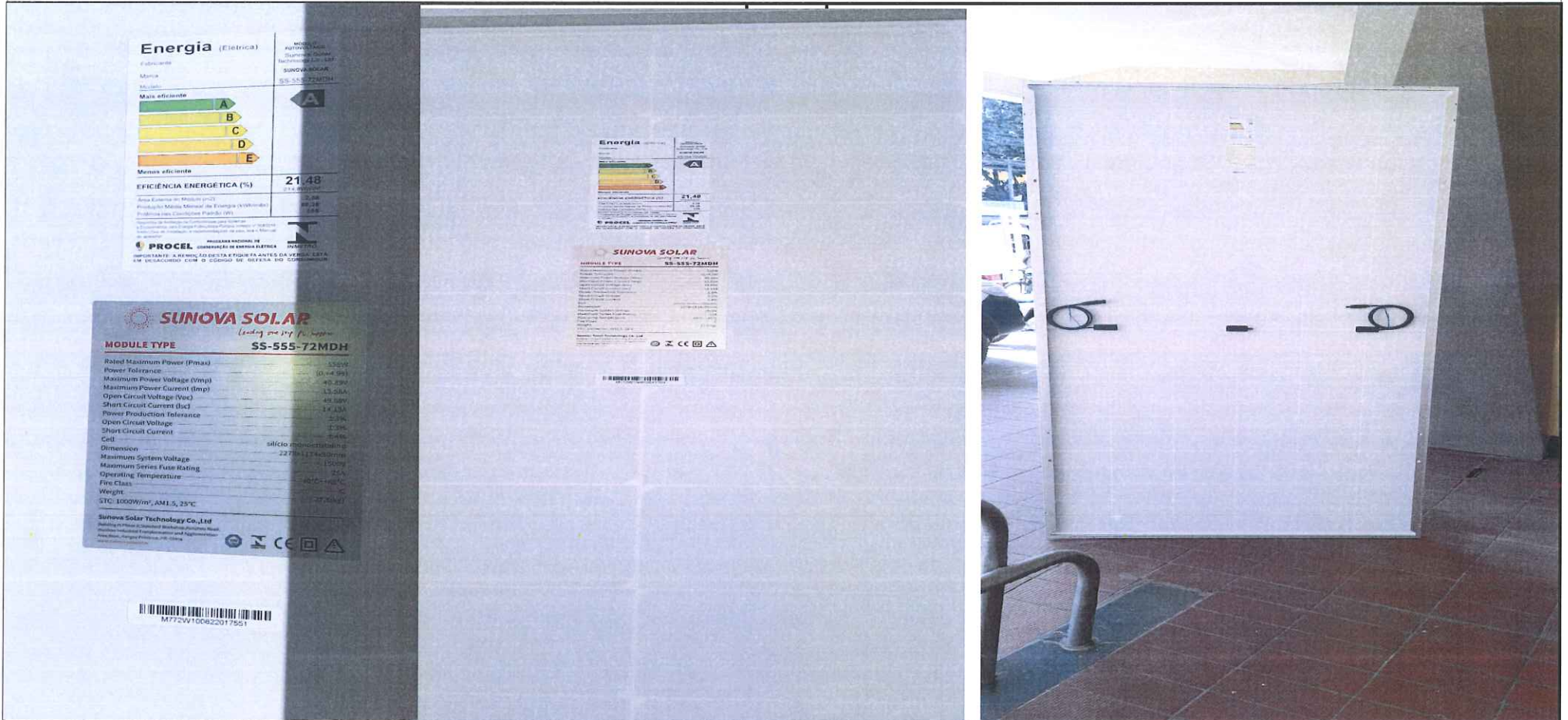



Prefeitura Municipal de Muriaé
Estado de Minas Gerais
C.G.C.: 17.947.581/0001-76

RELATÓRIO FOTOGRÁFICO

Objeto do Contrato:	ENERGIA SOLAR	Empresa Contratada:	Empreender Energia Solar Ltda
Local da Obra (Bairro, município e UF):	Centro Administrativo da Prefeitura Municipal de Muriaé	CNPJ:	35.886.443/0001-06
PREGÃO	092/2022	Contrato:	195001/22
		ORDEM DE SERVIÇO:	Modulos





Prefeitura Municipal de Muriaé
Estado de Minas Gerais
C.G.C.: 17.947.581/0001-76

RELATÓRIO FOTOGRÁFICO

Objeto do Contrato:	ENERGIA SOLAR	Empresa Contratada:	Empreender Energia Solar Ltda
Local da Obra (Bairro, município e UF):	Centro Administrativo da Prefeitura Municipal de Muriaé	CNPJ:	35.886.443/0001-06
	PREGÃO 092/2022		ORDEM DE SERVIÇO: Modulos
			Contrato: 195001/22





Prefeitura Municipal de Muriaé
Estado de Minas Gerais
C.G.C.: 17.947.581/0001-76

RELATÓRIO FOTOGRÁFICO

Objeto do Contrato:

ENERGIA SOLAR

Empresa Contratada:

Empreender Energia Solar Ltda

Local da Obra (Bairro, município e UF):

Centro Administrativo da Prefeitura Municipal de Muriaé

CNPJ: 35.886.443/0001-06

ORDEM DE SERVIÇO: Modulos

PREGÃO 092/2022

Contrato: 195001/22





Prefeitura Municipal de Muriaé
Estado de Minas Gerais
C.G.C.: 17.947.581/0001-76

RELATÓRIO FOTOGRÁFICO

Objeto do Contrato:	ENERGIA SOLAR	Empresa Contratada:	Empreender Energia Solar Ltda
Local da Obra (Bairro, município e UF):	Centro Administrativo da Prefeitura Municipal de Muriaé	CNPJ:	35.886.443/0001-06
PREGÃO	092/2022	Contrato:	195001/22
		ORDEM DE SERVIÇO:	Modulos





Prefeitura Municipal de Muriaé
Estado de Minas Gerais
C.G.C.: 17.947.581/0001-76

RELATÓRIO FOTOGRÁFICO

Objeto do Contrato:	ENERGIA SOLAR	Empresa Contratada:	Empreender Energia Solar Ltda
Local da Obra (Bairro, município e UF):	Centro Administrativo da Prefeitura Municipal de Muriaé	CNPJ:	35.886.443/0001-06
PREGÃO	092/2022	Contrato:	195001/22
		ORDEM DE SERVIÇO:	Modulos

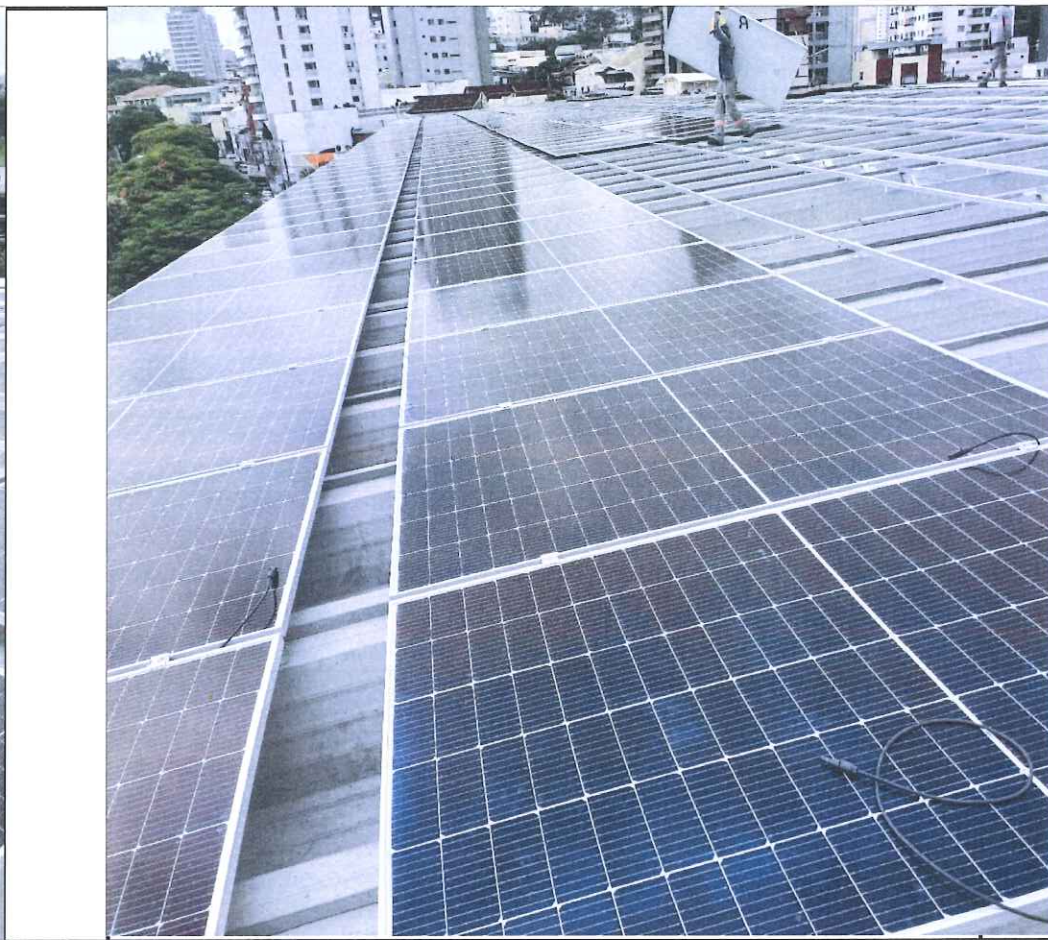

RELATÓRIO FOTOGRÁFICO



Prefeitura Municipal de Muriaé
Estado de Minas Gerais
C.G.C.: 17.947.581/0001-76

Objeto do Contrato: **ENERGIA SOLAR**

Empresa Contratada: **Empreender Energia Solar Ltda**

Local da Obra (Bairro, município e UF):
Centro Administrativo da Prefeitura Municipal de Muriaé

CNPJ: 35.886.443/0001-06

ORDEM DE SERVIÇO: Modulos

PREGÃO **092/2022**

Contrato: **195001/22**





Prefeitura Municipal de Muriaé
Estado de Minas Gerais
C.G.C.: 17.947.581/0001-76

RELATÓRIO FOTOGRÁFICO

Objeto do Contrato:	ENERGIA SOLAR	Empresa Contratada:	Empreender Energia Solar Ltda
Local da Obra (Bairro, município e UF):	Centro Administrativo da Prefeitura Municipal de Muriaé	CNPJ:	35.886.443/0001-06
PREGÃO	092/2022	Contrato:	195001/22
		ORDEM DE SERVIÇO:	Modulos

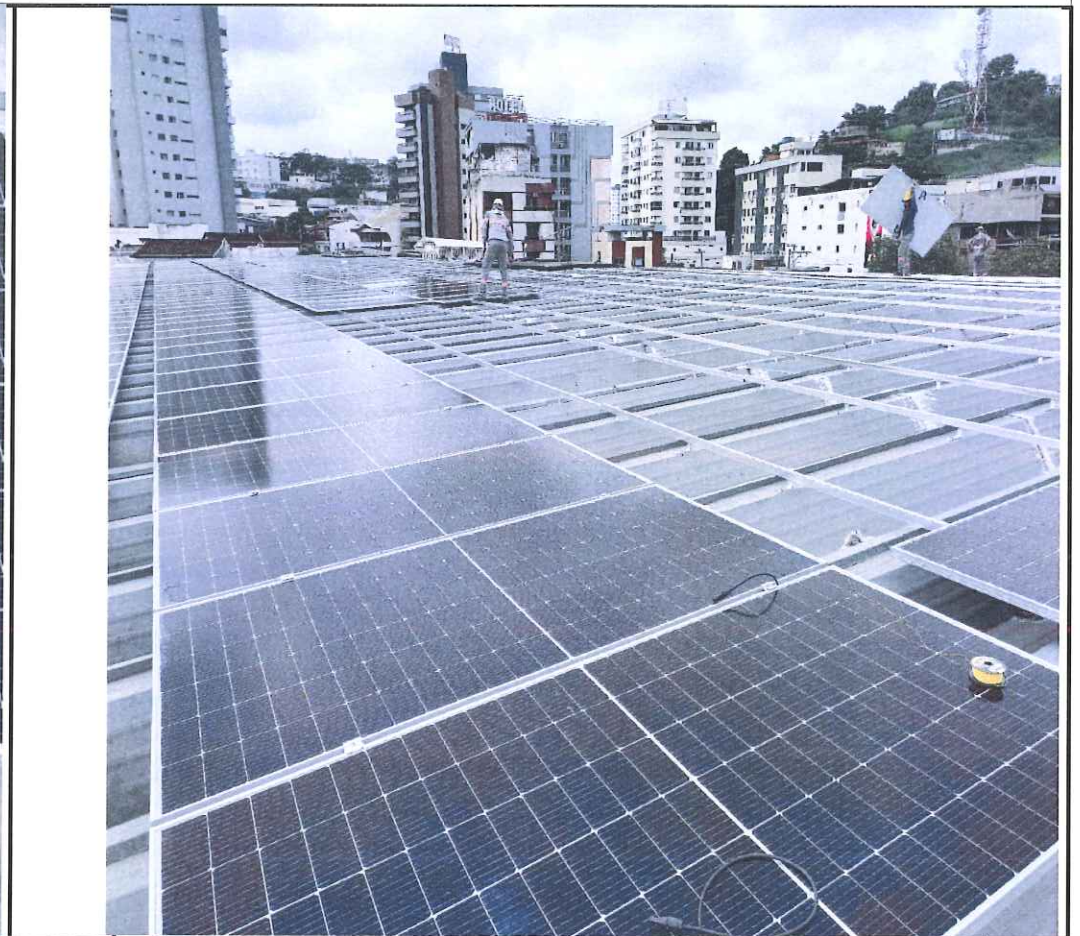



Prefeitura Municipal de Muriaé
Estado de Minas Gerais
C.G.C.: 17.947.581/0001-76

RELATÓRIO FOTOGRÁFICO

Objeto do Contrato:	ENERGIA SOLAR	Empresa Contratada:	Empreender Energia Solar Ltda
Local da Obra (Bairro, município e UF):	Centro Administrativo da Prefeitura Municipal de Muriaé	CNPJ:	35.886.443/0001-06
	PREGÃO 092/2022		ORDEM DE SERVIÇO: Modulos
			Contrato: 195001/22





Prefeitura Municipal de Muriaé
Estado de Minas Gerais
C.G.C.: 17.947.581/0001-76

RELATÓRIO FOTOGRÁFICO

Objeto do Contrato:

ENERGIA SOLAR

Empresa Contratada:

Empreender Energia Solar Ltda

Local da Obra (Bairro, município e UF):

Centro Administrativo da Prefeitura Municipal de Muriaé

CNPJ: 35.886.443/0001-06

ORDEM DE SERVIÇO: Modulos

PREGÃO 092/2022

Contrato: 195001/22

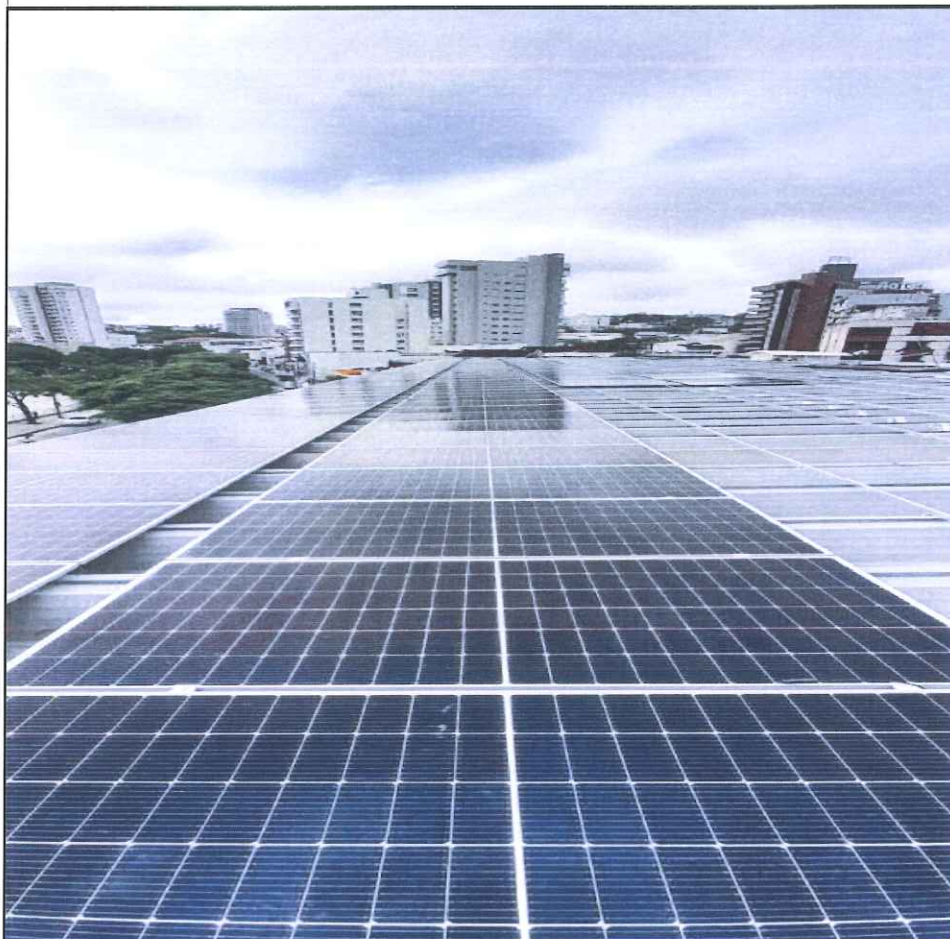

RELATÓRIO FOTOGRÁFICO



Prefeitura Municipal de Muriaé
Estado de Minas Gerais
C.G.C.: 17.947.581/0001-76

Objeto do Contrato: **ENERGIA SOLAR**

Empresa Contratada: **Empreender Energia Solar Ltda**

Local da Obra (Bairro, município e UF):
Centro Administrativo da Prefeitura Municipal de Muriaé

CNPJ: 35.886.443/0001-06

ORDEM DE SERVIÇO: Modulos

PREGÃO **092/2022**

Contrato: **195001/22**



Prefeitura Municipal de Muriaé
Placa Solar Centro Administrativo
17.01.2023 11:19
21°7'41,67"S 42°22'12,25"O (±13m)
Altitude: 194m
Avenida, Av. Maestro Sansão, - MG



Prefeitura Municipal de Muriaé
Placa Solar Centro Administrativo
18.01.2023 14:12
21°7'42,33"S 42°22'12,06"O (±18m)
Altitude: 194m
Avenida, Terminal Rodoviário de - Av. Constantino Pinto, - MG



RELATÓRIO FOTOGRÁFICO



Prefeitura Municipal de Muriaé
Estado de Minas Gerais
C.G.C.: 17.947.581/0001-76

Objeto do Contrato: **ENERGIA SOLAR**

Empresa Contratada: **Empreender Energia Solar Ltda**

Local da Obra (Bairro, município e UF):
Centro Administrativo da Prefeitura Municipal de Muriaé

CNPJ: 35.886.443/0001-06

ORDEM DE SERVIÇO: Modulos

PREGÃO **092/2022**

Contrato: **195001/22**



Prefeitura Municipal Muriaé
Solar
19.01.2023 16:44
21°7'41,56"S 42°22'12,25"O
Av. Maestro Sansão, 236 - MG, 36880-000



Prefeitura Municipal Muriaé
Solar
19.01.2023 16:46
21°7'42,18"S 42°22'12,13"O
Terminal Rodoviário de - Av. Constantino Pinto, 344 - MG,
36880-000



Prefeitura Municipal de Muriaé
Estado de Minas Gerais
C.G.C.: 17.947.581/0001-76

RELATÓRIO FOTOGRÁFICO

Objeto do Contrato:	ENERGIA SOLAR	Empresa Contratada:	Empreender Energia Solar Ltda
Local da Obra (Bairro, município e UF):	Centro Administrativo da Prefeitura Municipal de Muriaé	CNPJ:	35.886.443/0001-06
	PREGÃO 092/2022		ORDEM DE SERVIÇO: Modulos
			Contrato: 195001/22



RELATÓRIO FOTOGRÁFICO



Prefeitura Municipal de Muriaé
Estado de Minas Gerais
C.G.C.: 17.947.581/0001-76

Objeto do Contrato: **ENERGIA SOLAR**

Empresa Contratada: **Empreender Energia Solar Ltda**

Local da Obra (Bairro, município e UF):
Centro Administrativo da Prefeitura Municipal de Muriaé

CNPJ: 35.886.443/0001-06

ORDEM DE SERVIÇO: Modulos

PREGÃO **092/2022**

Contrato: **195001/22**





Prefeitura Municipal de Muriaé
Estado de Minas Gerais
C.G.C.: 17.947.581/0001-76

RELATÓRIO FOTOGRÁFICO

Objeto do Contrato:	ENERGIA SOLAR	Empresa Contratada:	Empreender Energia Solar Ltda
Local da Obra (Bairro, município e UF):	Centro Administrativo da Prefeitura Municipal de Muriaé	CNPJ:	35.886.443/0001-06
	PREGÃO 092/2022		ORDEM DE SERVIÇO: Modulos
			Contrato: 195001/22

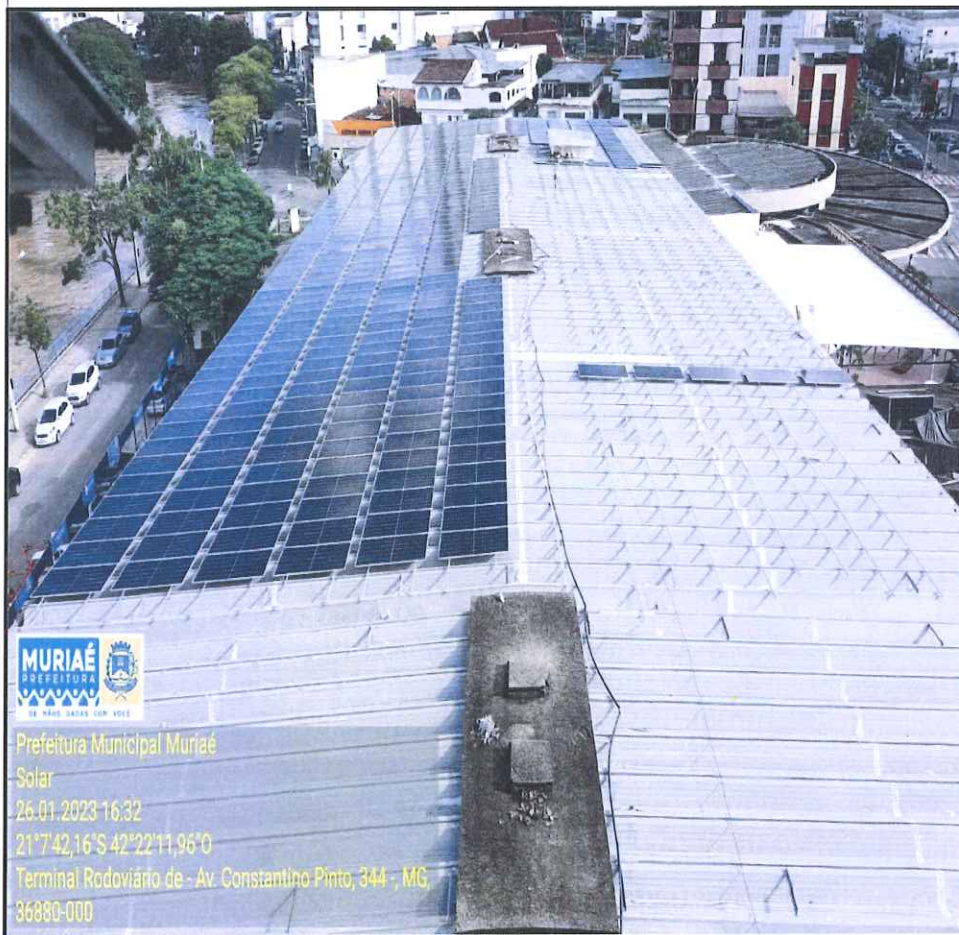



Prefeitura Municipal de Muriaé
Estado de Minas Gerais
C.G.C.: 17.947.581/0001-76

RELATÓRIO FOTOGRÁFICO

Objeto do Contrato: **ENERGIA SOLAR**

Empresa Contratada: **Empreender Energia Solar Ltda**

Local da Obra (Bairro, município e UF):

Centro Administrativo da Prefeitura Municipal de Muriaé

CNPJ: 35.886.443/0001-06

ORDEM DE SERVIÇO: Modulos

PREGÃO 092/2022

Contrato: 195001/22

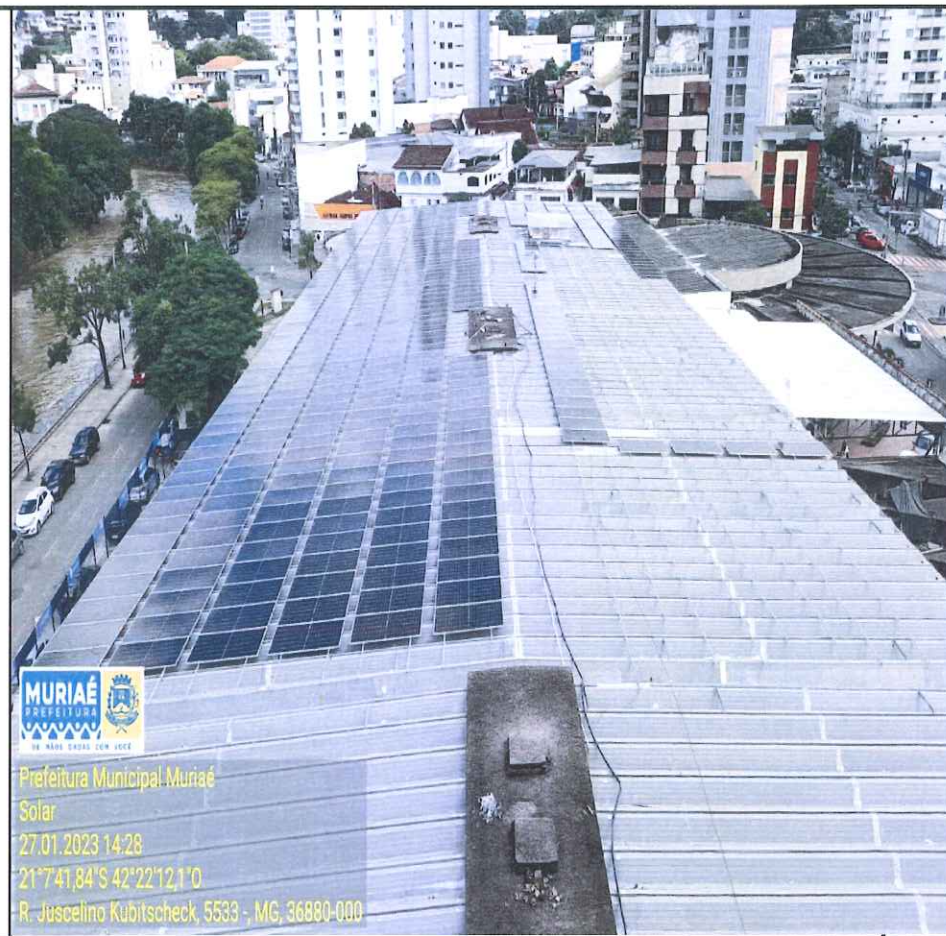

RELATÓRIO FOTOGRÁFICO



Prefeitura Municipal de Muriaé
Estado de Minas Gerais
C.G.C.: 17.947.581/0001-76

Objeto do Contrato: **ENERGIA SOLAR**

Empresa Contratada: **Empreender Energia Solar Ltda**

Local da Obra (Bairro, município e UF):
Centro Administrativo da Prefeitura Municipal de Muriaé

CNPJ: 35.886.443/0001-06

ORDEM DE SERVIÇO: Modulos

PREGÃO 092/2022

Contrato: 195001/22

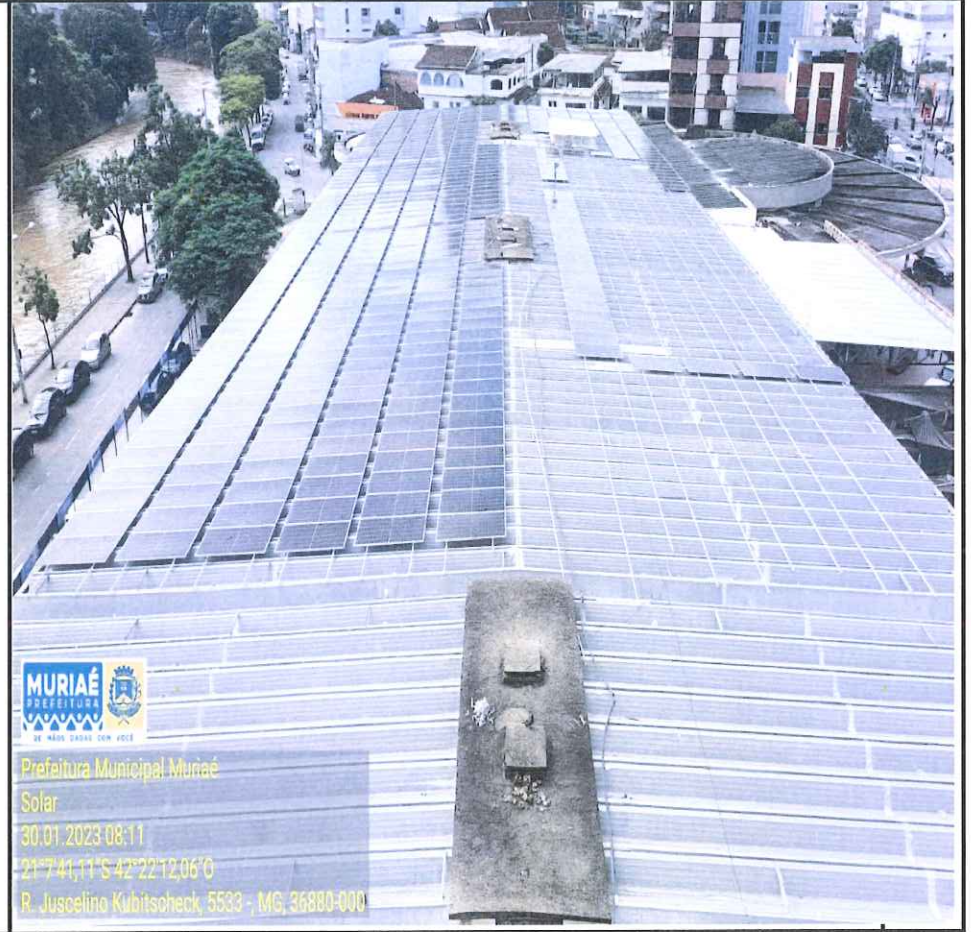



Prefeitura Municipal de Muriaé
Estado de Minas Gerais
C.G.C.: 17.947.581/0001-76

RELATÓRIO FOTOGRÁFICO

Objeto do Contrato:	ENERGIA SOLAR	Empresa Contratada:	Empreender Energia Solar Ltda
Local da Obra (Bairro, município e UF):	Centro Administrativo da Prefeitura Municipal de Muriaé	CNPJ:	35.886.443/0001-06
	PREGÃO 092/2022		ORDEM DE SERVIÇO: Modulos
			Contrato: 195001/22





Prefeitura Municipal de Muriaé
Estado de Minas Gerais
C.G.C.: 17.947.581/0001-76

RELATÓRIO FOTOGRÁFICO

Objeto do Contrato:	ENERGIA SOLAR	Empresa Contratada:	Empreender Energia Solar Ltda
Local da Obra (Bairro, município e UF):	Centro Administrativo da Prefeitura Municipal de Muriaé	CNPJ:	35.886.443/0001-06
	PREGÃO 092/2022		ORDEM DE SERVIÇO: Modulos
			Contrato: 195001/22

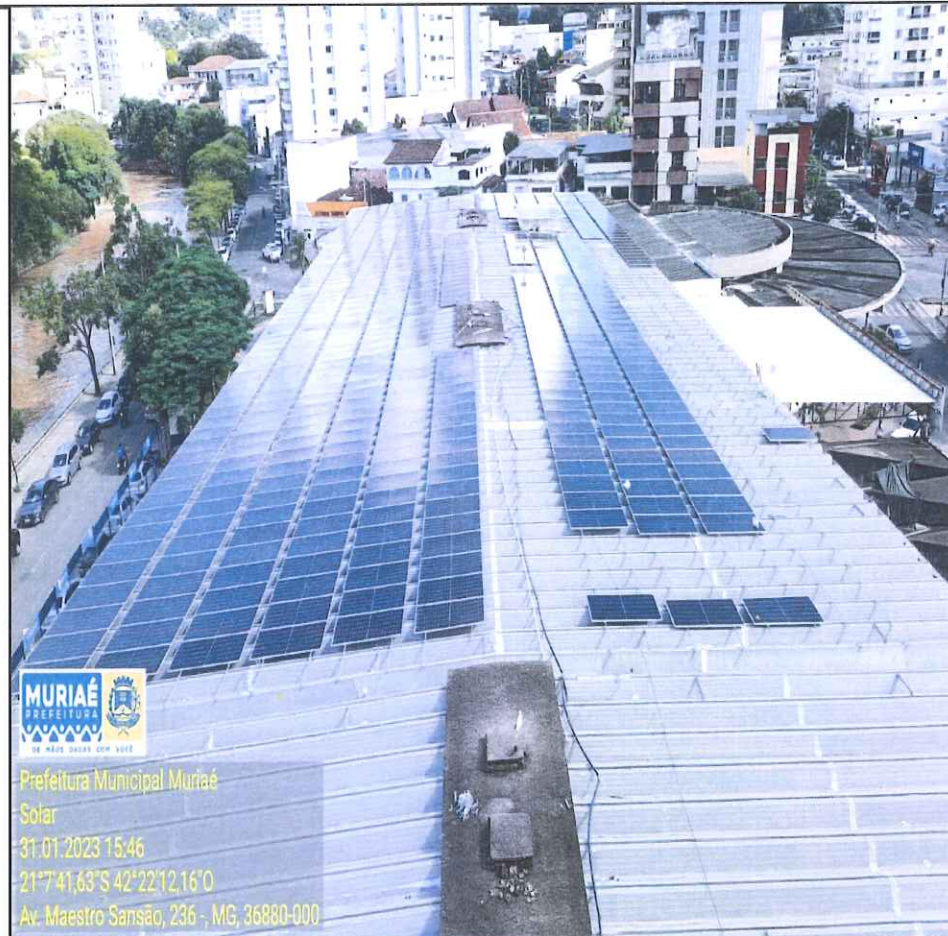



Prefeitura Municipal de Muriaé
Estado de Minas Gerais
C.G.C.: 17.947.581/0001-76

RELATÓRIO FOTOGRÁFICO

Objeto do Contrato:

ENERGIA SOLAR

Empresa Contratada:

Empreender Energia Solar Ltda

Local da Obra (Bairro, município e UF):

Centro Administrativo da Prefeitura Municipal de Muriaé

CNPJ: 35.886.443/0001-06

ORDEM DE SERVIÇO: Modulos

PREGÃO 092/2022

Contrato: 195001/22

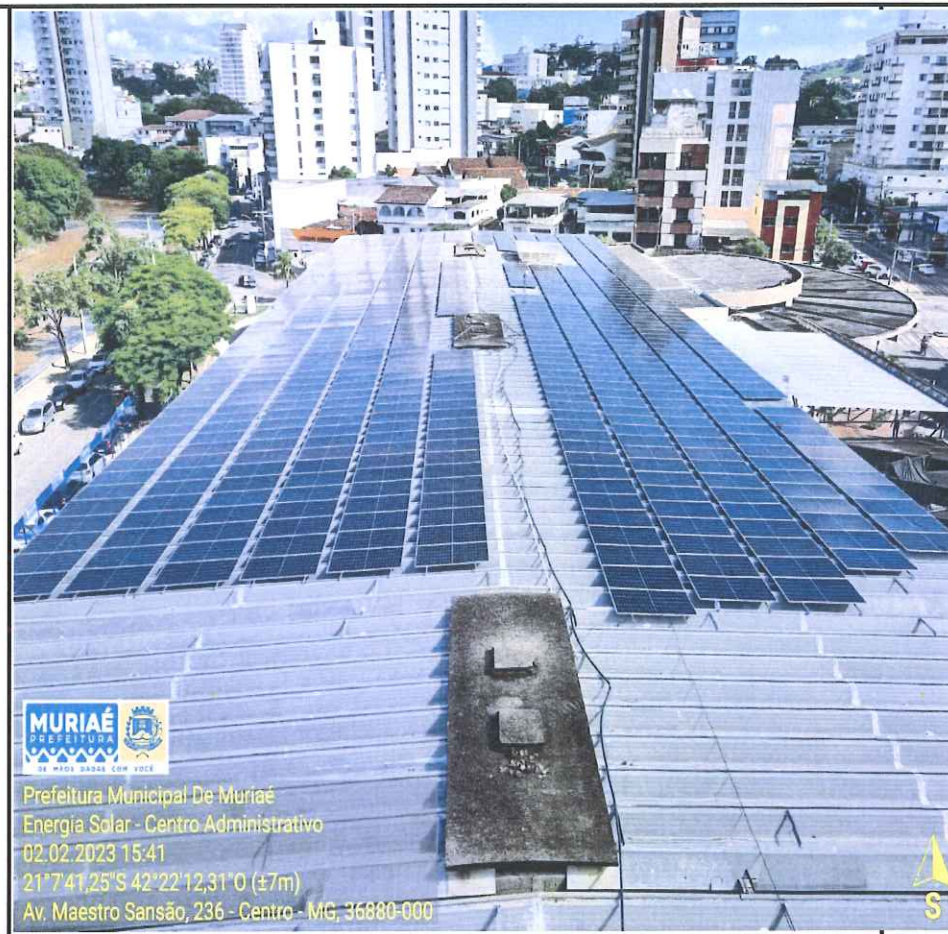
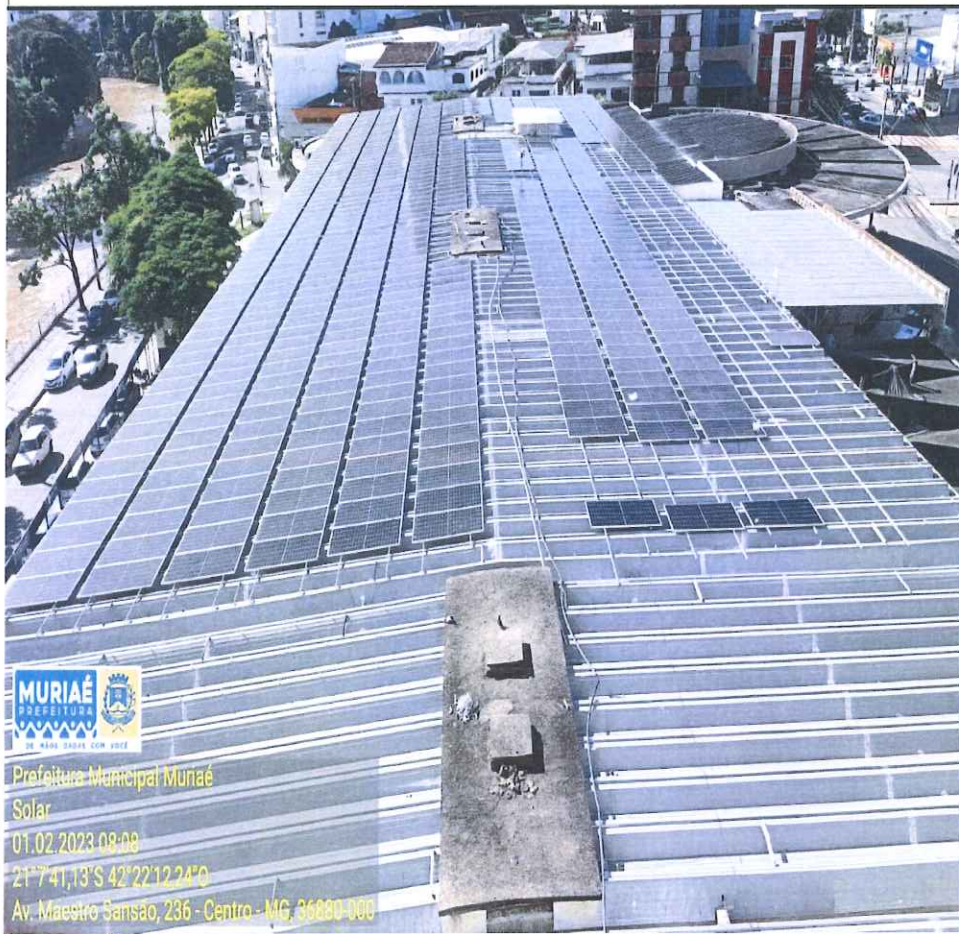



Prefeitura Municipal de Muriaé
Estado de Minas Gerais
C.G.C.: 17.947.581/0001-76

RELATÓRIO FOTOGRÁFICO

Objeto do Contrato:	ENERGIA SOLAR	Empresa Contratada:	Empreender Energia Solar Ltda
Local da Obra (Bairro, município e UF):	Centro Administrativo da Prefeitura Municipal de Muriaé	CNPJ:	35.886.443/0001-06
	PREGÃO 092/2022		ORDEM DE SERVIÇO: Modulos
			Contrato: 195001/22



Prefeitura Municipal De Muriaé
Energia Solar - Centro Administrativo
03.02.2023 08:11
21°7'41,68"S 42°22'12,14"O (±9m)
Terminal Rodoviario de - Av. Constantino Pinto, 344 -
MG, 36880-000